



■ Features

- Constant Current mode output
- Metal housing with Class I design
- Built-in active PFC function
- IP67 / IP65 design for indoor or outdoor installations
- Function options: output adjustable via potentiometer; 3 in 1 dimming; Timer dimming
- Typical lifetime > 62000 hours
- 7 years warranty

■ Applications

- LED street lighting
- LED fishing lamp
- LED harbor lighting
- LED building architectural lighting
- LED greenhouse lighting
- LED bay lighting

■ Description

HLG-120H-C series is a 150W AC/DC LED driver featuring the constant current mode and high voltage output. HLG-120H-C operates from 90~305VAC and offers models with different rated current ranging between 350mA and 1400mA. Thanks to the high efficiency up to 94%, with the fanless design, the entire series is able to operate for -40°C ~ +90°C case temperature under free air convection. The design of metal housing and IP67/IP65 ingress protection level allows this series to fit both indoor and outdoor applications. HLG-120H-C is equipped with various function options, such as dimming methodologies, so as to provide the optimal design flexibility for LED lighting system.

■ Model Encoding

HLG - 120 H - C500 A

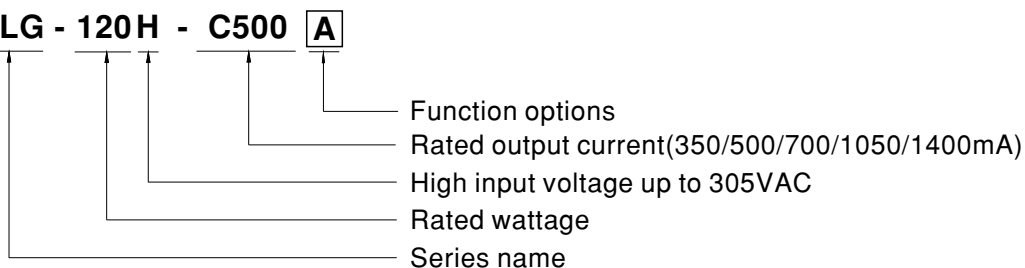

Type	IP Level	Function	Note
A	IP65	Io adjustable through built-in potentiometer.	In Stock
B	IP67	3 in 1 dimming function (1~10Vdc, 10V PWM signal and resistance)	In Stock
D	IP67	Timer dimming function, contact MEAN WELL for details(safety pending).	By request

**SPECIFICATION**

MODEL		HLG-120H-C350□	HLG-120H-C500□	HLG-120H-C700□	HLG-120H-C1050□	HLG-120H-C1400□
OUTPUT	RATED CURRENT	350mA	500mA	700mA	1050mA	1400mA
	RATED POWER	150.5W	150W	150.5W	155.4W	151.2W
	CONSTANT CURRENT REGION <small>Note.2</small>	215 ~ 430V	150V ~ 300V	107V ~ 215V	74V ~ 148V	54V ~ 108V
	CURRENT ADJ. RANGE	Adjustable for A-Type only (via built-in potentiometer)				
		175 ~ 350mA	250 ~ 500mA	350 ~ 700mA	525 ~ 1050mA	700 ~ 1400mA
	CURRENT RIPPLE	8.0% max. @rated current				
	CURRENT TOLERANCE	±5%				
SET UP TIME <small>Note.4</small>	1000ms / 115VAC	500ms / 230VAC				
INPUT	VOLTAGE RANGE <small>Note.3</small>	90 ~ 305VAC 127 ~ 431VDC (Please refer to "STATIC CHARACTERISTIC" section)				
	FREQUENCY RANGE	47 ~ 63Hz				
	POWER FACTOR (Typ.)	PF ≥ 0.98/115VAC, PF ≥ 0.96/230VAC, PF ≥ 0.93/277VAC @full load (Please refer to "POWER FACTOR (PF) CHARACTERISTIC" section)				
	TOTAL HARMONIC DISTORTION	THD < 20% (@ load ≥ 50% /115VAC, 230VAC; @ load ≥ 75%/277VAC) (Please refer to "TOTAL HARMONIC DISTORTION (THD)" section)				
	EFFICIENCY (Typ.)	94%	94%	94%	94%	93.5%
	AC CURRENT (Typ.)	1.6A / 115VAC	0.8 A / 230VAC	0.7A / 277VAC		
	INRUSH CURRENT(Typ.)	COLD START 50A(t _{width} =600μs measured at 50% I _{peak}) at 230VAC; Per NEMA 410				
	MAX. No. of PSUs on 16A CIRCUIT BREAKER	4 units (circuit breaker of type B) / 6 units (circuit breaker of type C) at 230VAC				
	LEAKAGE CURRENT	<0.75mA / 277VAC				
PROTECTION	SHORT CIRCUIT	Constant current limiting, recovers automatically after fault condition is removed				
	OVER VOLTAGE	475 ~ 495V	335 ~ 355V	240 ~ 260V	165 ~ 175V	120 ~ 130V
	OVER TEMPERATURE	Shut down o/p voltage, recovers automatically after temperature goes down				
ENVIRONMENT	WORKING TEMP.	T _{case} = -40 ~ +90°C (Please refer to "OUTPUT LOAD vs TEMPERATURE" section)				
	MAX. CASE TEMP.	T _{case} = +90°C				
	WORKING HUMIDITY	10 ~ 95% RH non-condensing				
	STORAGE TEMP., HUMIDITY	-40 ~ +80°C, 10 ~ 95% RH				
	TEMP. COEFFICIENT	±0.03%/°C (0 ~ 50°C)				
	VIBRATION	10 ~ 500Hz, 5G 12min./1cycle, period for 72min. each along X, Y, Z axes				
SAFETY & EMC	SAFETY STANDARDS <small>Note.6</small>	UL8750, CSA C22.2 No. 250.13-12, ENEC EN61347-1, EN61347-2-13, EN62384 independent, IP65 or IP67, J61347-1, J61347-2-13 approved				
	WITHSTAND VOLTAGE	I/P-O/P:3.75KVAC I/P-FG:2KVAC O/P-FG:1.5KVAC				
	ISOLATION RESISTANCE	I/P-O/P, I/P-FG, O/P-FG:100M Ohms / 500VDC / 25°C / 70% RH				
	EMC EMISSION <small>Note.6</small>	Compliance to EN55015, EN61000-3-2 Class C (@ load ≥ 50%) ; EN61000-3-3				
	EMC IMMUNITY	Compliance to EN61000-4-2,3,4,5,6,8,11, EN61547, light industry level (surge immunity Line-Earth 4KV, Line-Line 2KV)				
OTHERS	MTBF	652.2K hrs min. Telcordia SR-332 (Bellcore) ; 191.1K hrs min. MIL-HDBK-217F (25°C)				
	DIMENSION	220*68*38.8mm (L*W*H)				
	PACKING	1.04Kg; 12pcs/13.5Kg/0.8CUFT				
NOTE	<ol style="list-style-type: none"> All parameters NOT specially mentioned are measured at 230VAC input, rated current and 25°C of ambient temperature. Please refer to "DRIVING METHODS OF LED MODULE". De-rating may be needed under low input voltages. Please refer to "STATIC CHARACTERISTIC" sections for details. Length of set up time is measured at first cold start. Turning ON/OFF the driver may lead to increase of the set up time. The driver is considered as a component that will be operated in combination with final equipment. Since EMC performance will be affected by the complete installation, the final equipment manufacturers must re-qualify EMC Directive on the complete installation again. The model certified for CCC(GB19510.14, GB19510.1, GB17743 and GB17625.1) is an optional model . Please contact MEAN WELL for details. To fulfill requirements of the latest ErP regulation for lighting fixtures, this LED driver can only be used behind a switch without permanently connected to the mains. This series meets the typical life expectancy of >62,000 hours of operation when T_{case}, particularly (T_c) point (or TMP, per DLC), is about 80°C or less. Please refer to the warranty statement on MEAN WELL's website at http://www.meanwell.com 					

■ BLOCK DIAGRAM

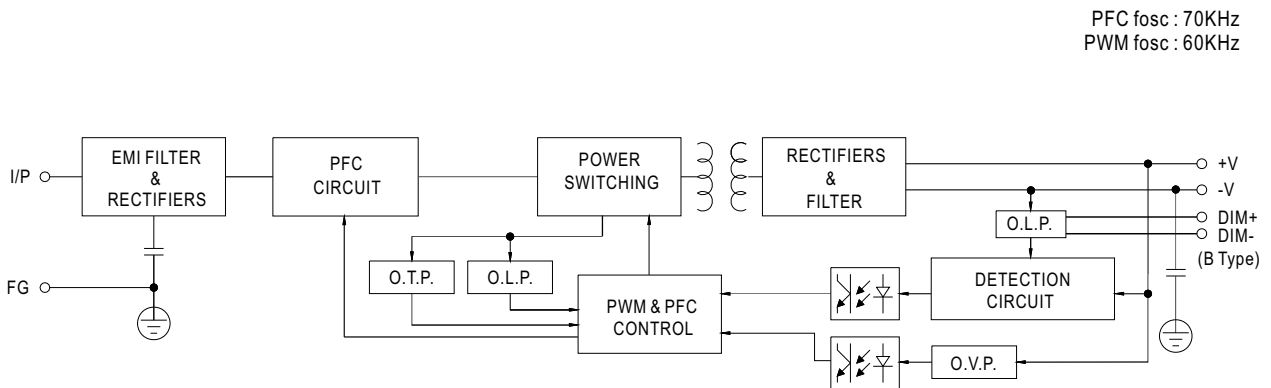

■ DRIVING METHODS OF LED MODULE

※ This series works in constant current mode to directly drive the LEDs.

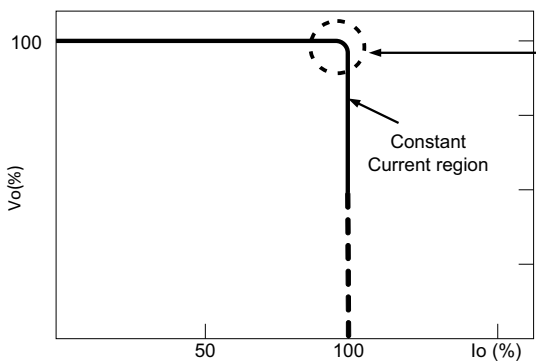

Typical output current normalized by rated current (%)

In the constant current region, the highest voltage at the output of the driver depends on the configuration of the end systems.

Should there be any compatibility issues, please contact MEAN WELL.

DIMMING OPERATION

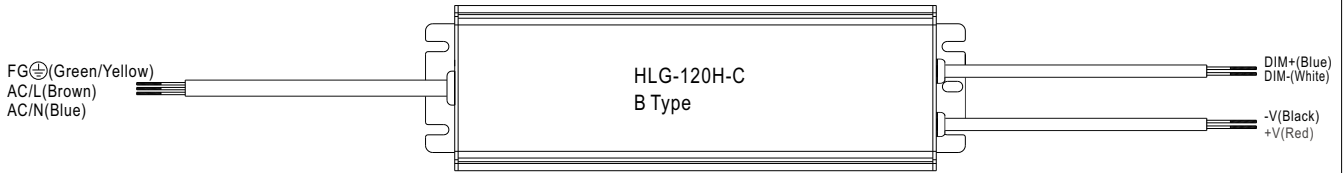

※ 3 in 1 dimming function (for B-Type)

- Output constant current level can be adjusted by applying one of the three methodologies between DIM+ and DIM-:
1 ~ 10VDC, or 10V PWM signal or resistance.
- Direct connecting to LEDs is suggested. It is not suitable to be used with additional drivers.
- Dimming source current from power supply: 100 μ A (typ.)

◎ Applying additive 1 ~ 10VDC

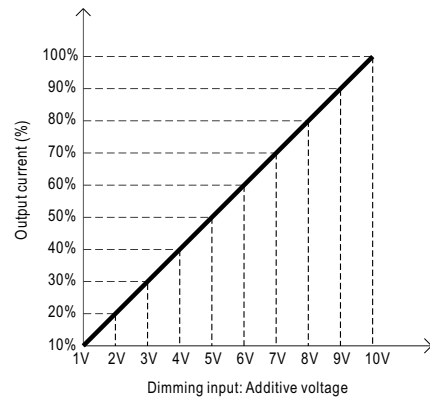
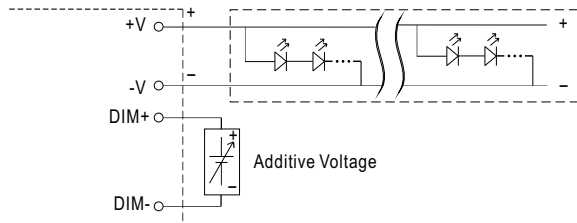

◎ Applying additive 10V PWM signal (frequency range 100Hz ~ 3KHz):

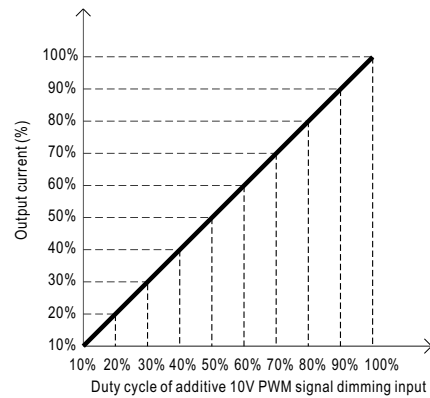
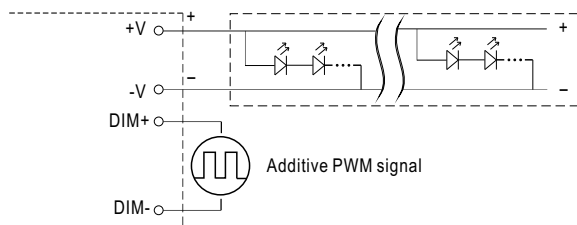

◎ Applying additive resistance:

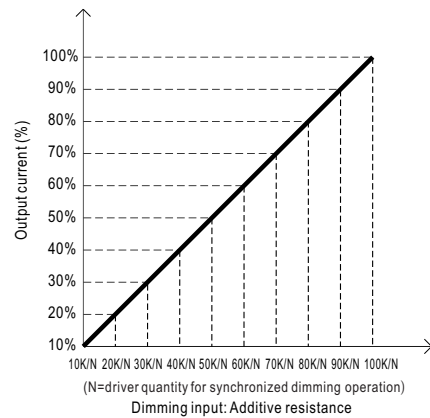
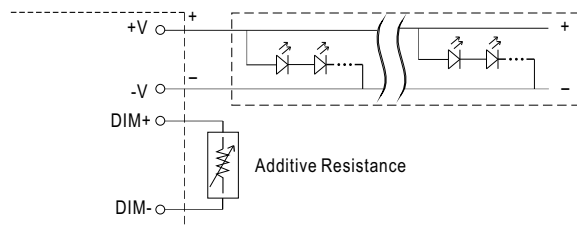

Note: In the case of turning the lighting fixture down to 0% brightness, please refer to the configuration as follow, or please contact MEAN WELL for other options.

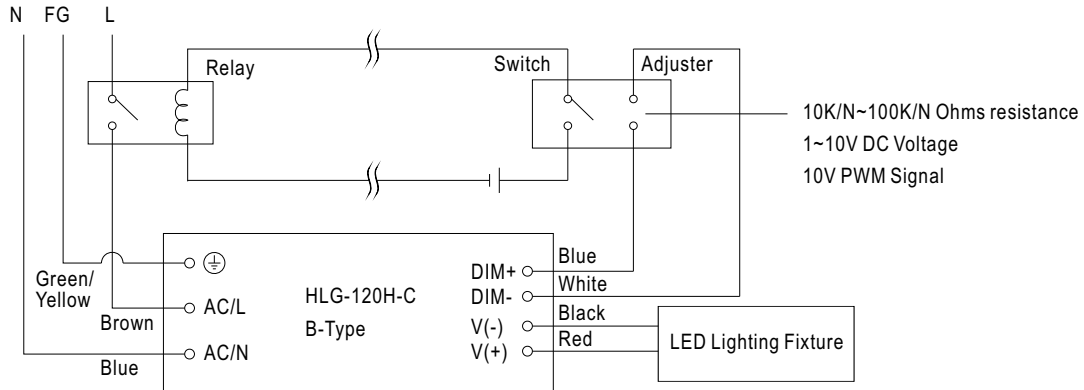

Using a switch and relay can turn ON/OFF the lighting fixture.

OUTPUT LOAD vs TEMPERATURE

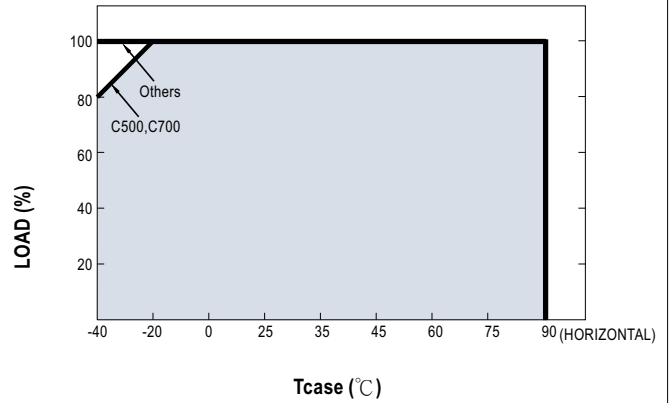
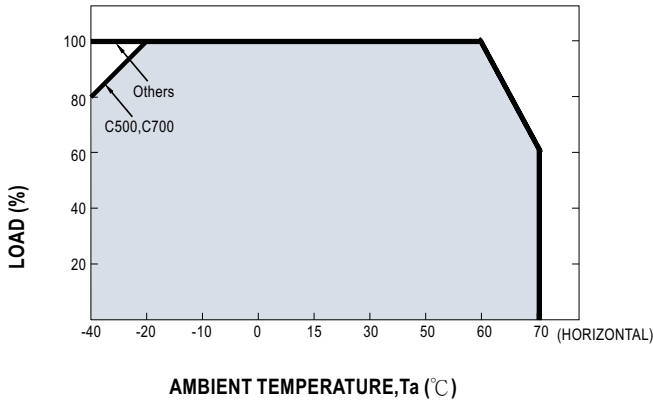

STATIC CHARACTERISTIC

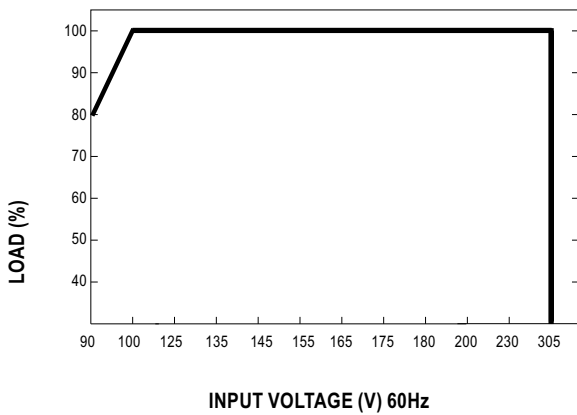

POWER FACTOR (PF) CHARACTERISTIC

※ T_{case} at 80°C

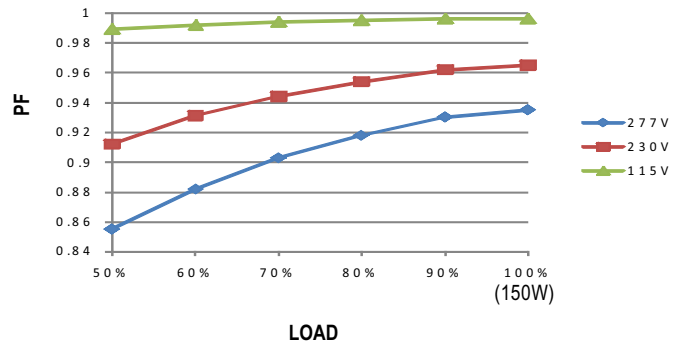

TOTAL HARMONIC DISTORTION (THD)

※ 700mA Model, T_{case} at 80°C

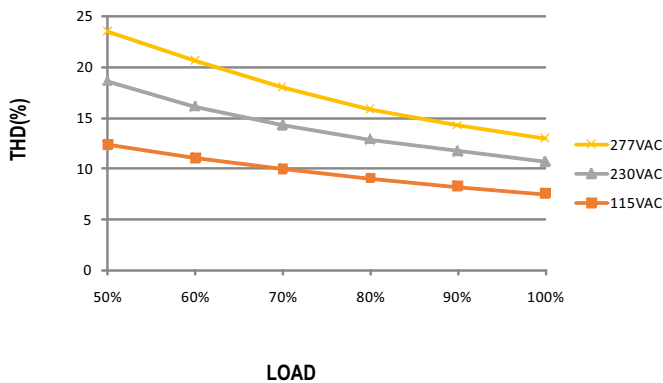

EFFICIENCY vs LOAD

HLG-120H-C series possess superior working efficiency that up to 94% can be reached in field applications.

※ 700mA Model, T_{case} at 80°C

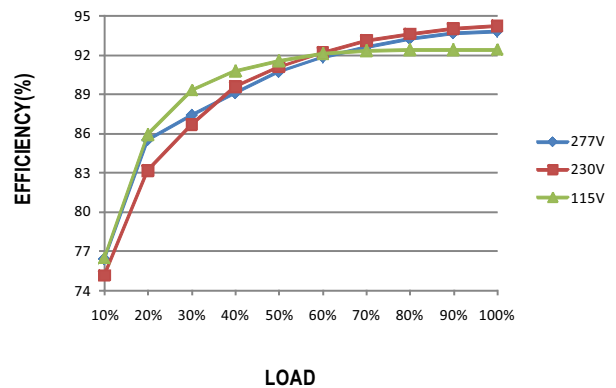



■ LIFE TIME

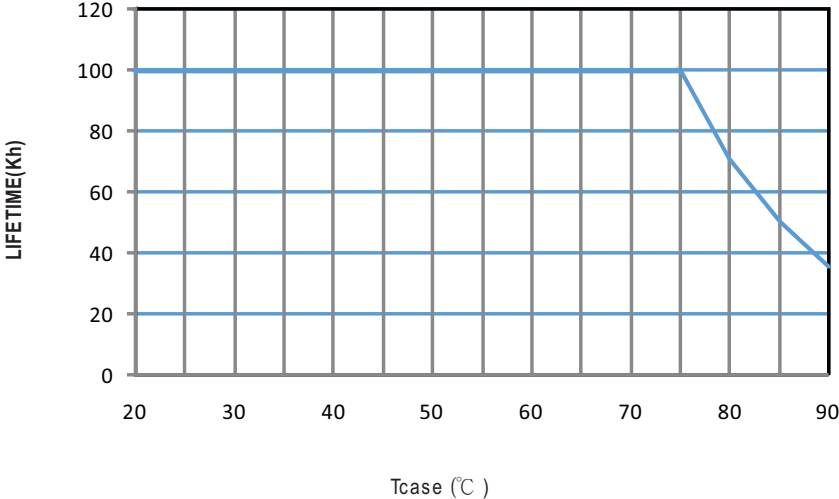

MECHANICAL SPECIFICATION

Case No.994 Unit:mm

※ A-Type

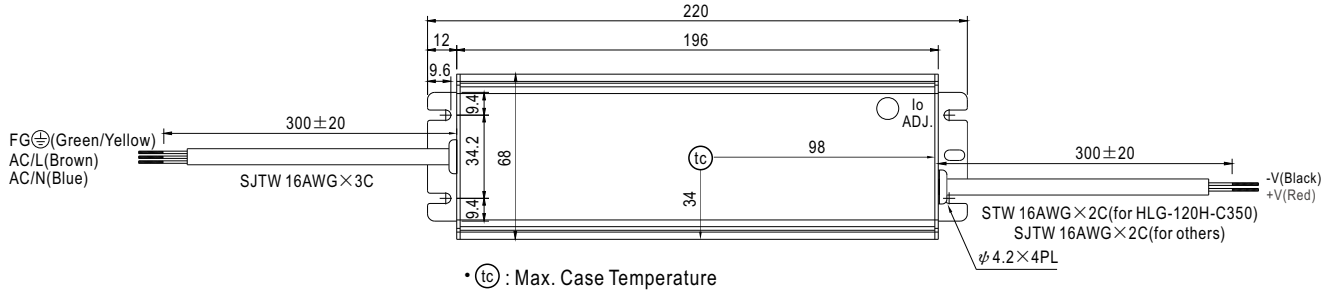

※ B-Type

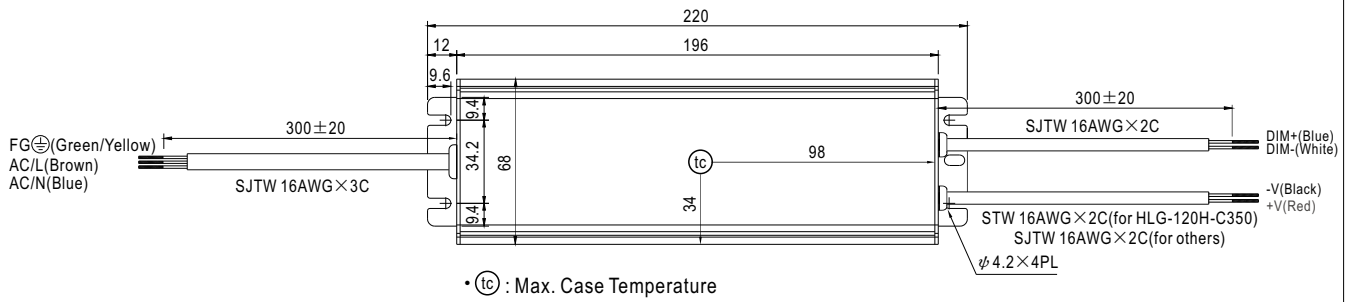

※ D-Type

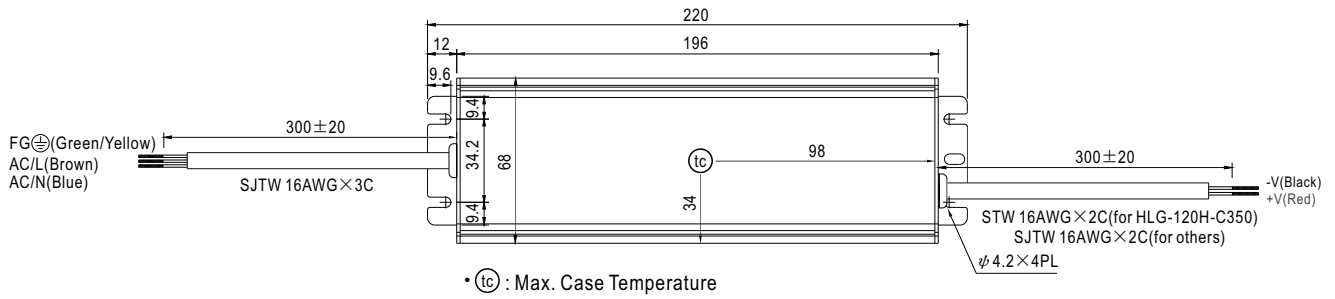

■ WATERPROOF CONNECTION

◎ Waterproof connector

Waterproof connector can be assembled on the output cable of HLG-120H-C to operate in dry/wet/damp or outdoor environment.

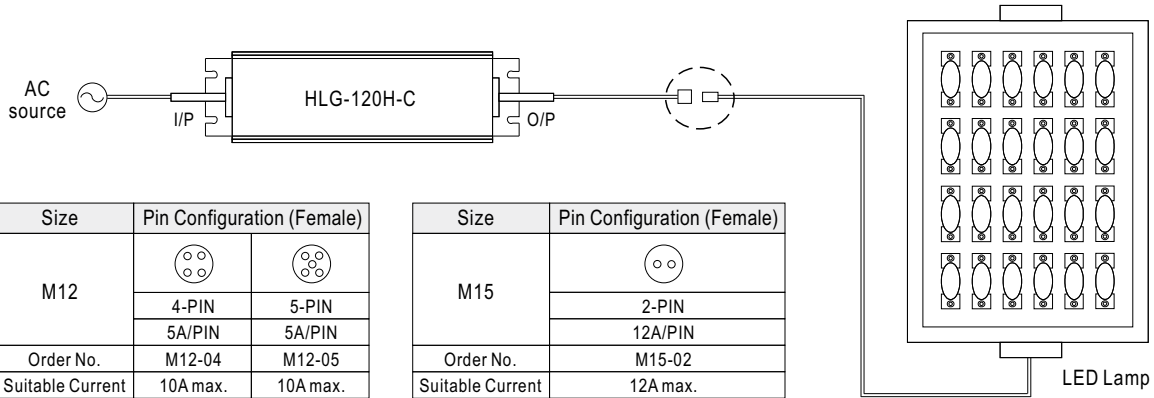

◎ Cable Joiner

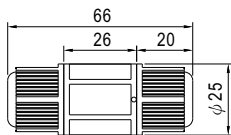

CJ04-1 suitable for 14AWG~16AWG
CJ04-2 suitable for 18AWG~22AWG



Up to four wires can be connected through this cable joiner by soldering or clamping by tools.

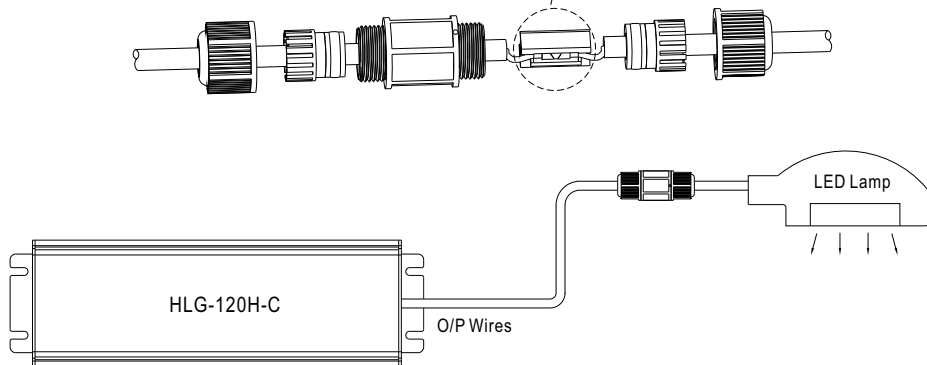

※CJ04 cable joiner can be purchased independently for user's own assembly.
MEAN WELL order No. : CJ04-1, CJ04-2.

■ INSTALLATION MANUAL

Please refer to : <http://www.meanwell.com/webnet/search/InstallationSearch.html>

Mouser Electronics

Authorized Distributor

Click to View Pricing, Inventory, Delivery & Lifecycle Information:

Mean Well:

[HLG-120H-C350B](#) [HLG-120H-C500A](#) [HLG-120H-C1400A](#) [HLG-120H-C1050A](#) [HLG-120H-C1050B](#) [HLG-120H-C700B](#) [HLG-120H-C350A](#) [HLG-120H-C500B](#) [HLG-120H-C1400B](#) [HLG-120H-C700A](#)